

◆ ◆ ◆ ◆ ◆
◆ ◆ ◆ ◆ ◆

Instruction manual

◆ ◆ ◆ ◆ ◆
◆ ◆ ◆ ◆ ◆

EL-FLOW *Base series* Mass Flow Controllers

Doc. no.: 9.17.061P Date: 28-04-2020

◆ ◆ ◆ ◆ ◆
◆ ◆ ◆ ◆ ◆
◆ ◆ ◆ ◆ ◆
◆ ◆ ◆ ◆ ◆

ATTENTION

**Please read this instruction manual carefully before installing and operating the instrument.
Not following the guidelines could result in personal injury and/or damage to the equipment.**

Even though care has been taken in the preparation and publication of the contents of this manual, we do not assume legal or other liability for any inaccuracy, mistake, mis-statement or any other error of whatsoever nature contained herein. The material in this manual is for information purposes only, and is subject to change without notice.

TABLE OF CONTENTS

Contents

1	General Product Information	5
1.1	Introduction	5
1.2	Intended Use.....	5
1.3	Symbols.....	5
1.4	Product Support References	5
1.5	Warranty	6
1.6	Product Description	6
1.6.1	General Description	6
1.6.2	Model Key	7
1.6.3	Seals	7
1.6.4	Calibration.....	8
1.6.5	Features	8
1.7	Operating Principles.....	9
1.7.1	Thermal Gas Flow Sensor Principle	9
1.7.2	Bypass Principle	9
1.7.3	Solenoid Valve Principle.....	10
1.8	Maintenance.....	10
2	Installation Instructions.....	11
2.1	Introduction	11
2.2	Unpacking and inspection.....	11
2.3	Rated pressure test inspection	11
2.4	Instrument mounting.....	11
2.5	Fluidic connections	12
2.6	In-line filter usage	12
2.7	Piping requirements	12
2.8	Electrical connections	13
2.8.1	Interface.....	13
2.8.2	Power Supply	13
2.9	Power and warm-up	13
2.10	Pressure supply / Start-up	13
2.11	System purging	14
2.12	Zeroing.....	14
3	Basic Operation.....	15
3.1	General	15
3.2	Analog operation	15
3.3	Digital communication protocol detection (Flow-BUS RS232 or MODBUS RS485)	16
3.4	Basic RS232 Flowbus operation	17
3.5	Modbus RS485 operation	18
3.5.1	Modbus termination	18
3.5.2	Slave address, baud rate and parity setup.....	19
3.5.3	Implementation class.....	23
3.5.4	Response time	23
3.5.5	Supported Modbus functions	23
3.5.6	Available parameters	24
3.6	Push-button operation	26
3.7	Micro-switch use for reading/changing control mode	27
3.7.1	Read control mode	27
3.7.2	Change control mode:	27
3.8	LED indications.....	28
3.9	Basic Parameters and Properties.....	29
3.9.1	Introduction	29
3.9.2	Basic Parameters.....	30
4	Advanced Operation.....	31
4.1	Reading and Changing Instrument Parameters	31

4.1.1	Introduction	31
4.1.2	Identification.....	31
4.1.3	Fluid Information	32
4.1.4	Auto Zeroing	32
4.1.5	Controller Response Adjustment.....	33
4.1.6	Changing Default Control Mode	34
4.1.7	Display Filter	35
4.1.8	Disabling Micro Switch.....	35
4.2	Using other gasses than specified.....	36
4.2.1	Software for conversion factor calculation.....	36
4.2.2	Maximum pressure drop	36
5	Troubleshooting.....	37
5.1	General	37
5.2	LED indications.....	37
5.3	Troubleshooting summary general.....	37
6	Removal and Return Instructions	39
7	Service	40

1 General Product Information

1.1 Introduction

This user guide covers the EL-FLOW *Base* Series mass flow controllers for gasses as shown in the pictures below. Included herein is product information, installation instructions, operation, maintenance, troubleshooting and technical specifications.



F-201CB
8 ml_n/min – 20 l_n/min



F-201AB
20 l_n/min – 70 l_n/min



F-202BB
70 l_n/min – 200 l_n/min

1.2 Intended Use

The intended use of EL-FLOW *Base* instruments is to control gas flow rates of the specified gas noted on the instrument label. The gas has to be clean.

The instruments can be used for either (fast) switching or controlling a constant flow rate.

1.3 Symbols



Important information. Discarding this information could cause injuries to people or damage to the Instrument or installation.



Helpful information. This information will facilitate the use of this instrument.



Additional info available on the internet or from your local sales representative.

1.4 Product Support References

Instructions:

Operating instructions digital instruments, document nr. 9.17.023.

RS232 interface with FLOW-BUS protocol, document nr. 9.17.027.

Technical drawings:

Hookup EL-FLOW *Base*, document nr. 9.16.091

Dimensional drawing F-201AB, document nr. 7.15.1

Dimensional drawing F-201CB, document nr. 7.15.166

Dimensional drawing F-202BB, document nr. 7.15.170



These documents can be found at:

<http://www.bronkhorst.com/en/downloads>

1.5 Warranty

The products of Bronkhorst® are warranted against defects in material and workmanship for a period of three years from the date of shipment, provided they are used in accordance with the ordering specifications and the instructions in this manual and that they are not subjected to abuse, physical damage or contamination.

Products that do not operate properly during this period may be repaired or replaced at no charge. Repairs are normally warranted for one year or the balance of the original warranty, whichever is the longer.

See also paragraph 9 of the Conditions of sales.

The warranty includes all initial and latent defects, random failures, and undeterminable internal causes.

It excludes failures and damage caused by the customer, such as contamination, improper electrical hook-up, physical shock etc.

Re-conditioning of products primarily returned for warranty service that is partly or wholly judged non-warranty may be charged for.

Bronkhorst High-Tech B.V. prepays outgoing freight charges when any part of the service is performed under warranty, unless otherwise agreed upon beforehand, however, if the product has been returned collect to Bronkhorst High-Tech B.V., these costs are added to the repair invoice. Import and/or export charges, foreign shipping methods/carriers are paid for by the customer.

1.6 Product Description

1.6.1 General Description

An EL-FLOW *Base* mass flow controller consists of a thermal mass flow sensor, a laminar flow element which acts as a bypass, a solenoid proportional control valve and a digital electronic PC-board for PID-control and communication.

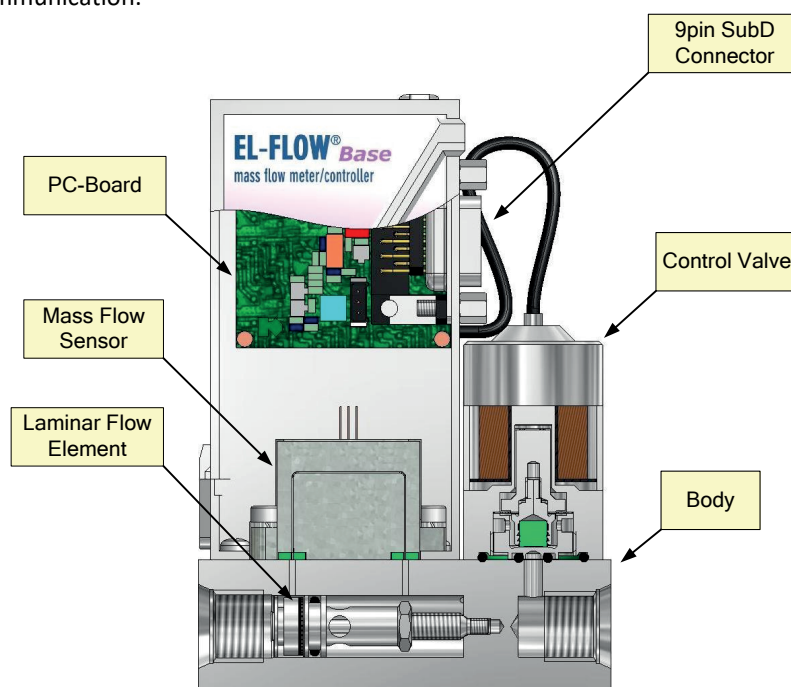

There are three different basic models for different flow rates (F-201CB, F-201AB and F-202BB). Within each model there is variation in laminar flow element size, orifice size and sealing material. These variables are optimized for the customer's gas and process conditions.

1.6.2 Model Key

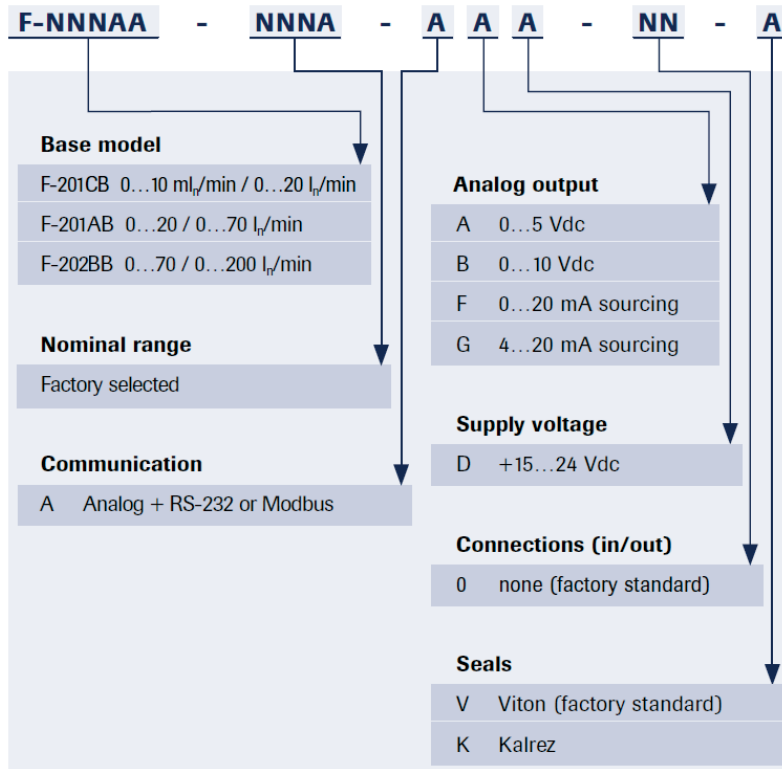

Example: F-201CB-200-ABD-00-V

Range: 200 ml/min
 Analog output: 0-10Vdc
 Seals: Viton

1.6.3 Seals

The instrument is fitted with either Viton or Kalrez seals. Which sealing material is used is shown in the last character of the model key. Bronkhorst® has gathered a material compatibility chart from a number of sources believed to be reliable. However, it is a general guide only. Operating conditions may substantially change the accuracy of this guide. Therefore there is no liability for damages accruing from the use of this guide. The customer's application will demand its own specific design or test evaluation for optimum reliability.



Check if the seals like O-rings, plunger and packing gland of capillary are suitable for the used gas and process.

1.6.4 Calibration

EL-FLOW *Base* instruments are Air or N2 calibrated. Bronkhorst® certifies that all instruments meet the rated accuracy. They have been calibrated using measurement standards traceable to the standards of the Dutch Metrology Institute (VSL).

The calibration is converted to the customer's gas and conditions using a detailed conversion model. This conversion adds a level of calibration uncertainty.

Thumb rule for calculating the conversion uncertainty is typical:

$$\begin{aligned} \text{Uncertainty} &< 2\% \times \text{CF} && \text{for CF} > 1 \\ \text{Uncertainty} &< 2\% / \text{CF} && \text{for CF} < 1 \end{aligned}$$

With CF defined as the approximate conversion factor, which can be calculated with:

$$CF = \frac{C_{p_1} \cdot \rho_1}{C_{p_2} \cdot \rho_2}$$

in which:

- | | |
|-----------|-------------------------------|
| C_{p_n} | specific heat |
| ρ_n | density at normal conditions |
| (1) | calibration fluid (Air or N2) |
| (2) | customer fluid |



Check FLUIDAT® on <http://www.fluidat.com>

FLUIDAT® is a collection of routines to calculate physical properties of gases and liquids. These routines are made available at the FLUIDAT® on the Net website.

EL-FLOW *Base* instruments are standard delivered without calibration certificate. Calibration certificates can be ordered together with the instruments. Contact your local sales representative for more information.

1.6.5 Features

Each instrument consists of an Analog interface, a digital RS-232 interface and a digital ModBus/RS485 interface. The analog and the digital interface can be used together at the same time.

According to the pin-designation both RS232 and Modbus/RS485 are assigned to the same pins. When connecting these pins to either of the two, the instrument will automatically detect which protocol to use.

Digital operation adds a lot of extra features (compared to analog operation) to the instruments.

Such as:

- setpoint slope (ramp function on setpoint for smooth control)
- direct reading at readout/control module or host computer
- several control/setpoint modes (e.g. purge/close valve)
- identification (serial number, model number, device type, user tag)
- adjustable controller settings for custom controller response

1.7 Operating Principles

1.7.1 Thermal Gas Flow Sensor Principle

The gas flow sensor operates on a principle of heat transfer by sensing the temperature difference along a heated section of a capillary tube. Part of the total flow is forced through the capillary by means of a laminar flow element in the main stream generating a pressure difference.

The design of the laminar flow device is such that flow conditions in both the capillary and laminar flow device are comparable, thereby resulting in proportional flow rates through the meter. The delta-T sensed by the upstream and downstream temperature sensors on the capillary depends on the amount of heat absorbed by the gas flow.

The transfer function between gas mass flow and signal can be described by the equation:

$$V_{\text{signal}} = K \cdot c_p \cdot \Phi_m$$

V_{signal} = output signal

c_p = specific heat

K = constant factor

Φ_m = mass flow

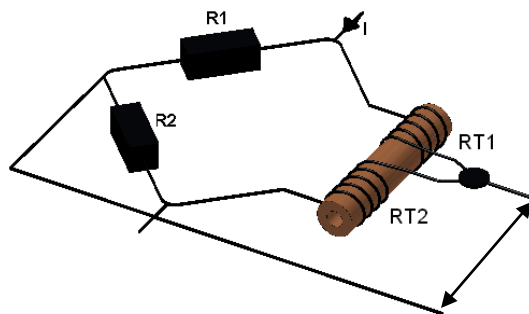

Thermal sensor in a bridge configuration

The temperature sensors are part of a bridge circuit. The imbalance is linearised and amplified to the desired signal level.

1.7.2 Bypass Principle

The measurement part of an EL-FLOW *Base* consists of a thermal sensor and a laminar flow element (LFE). A laminar flow element consists of a stack of discs with precision etched flow channels. The flow through each channel is proportional to the flow through the sensor. In this way, by adding more or less laminar flow discs, the total flow rate of an instrument can be adjusted while using the same sensor flow rate.

In general instruments with these sensors may be mounted horizontal, as well as in a vertical position, at low operating pressures.

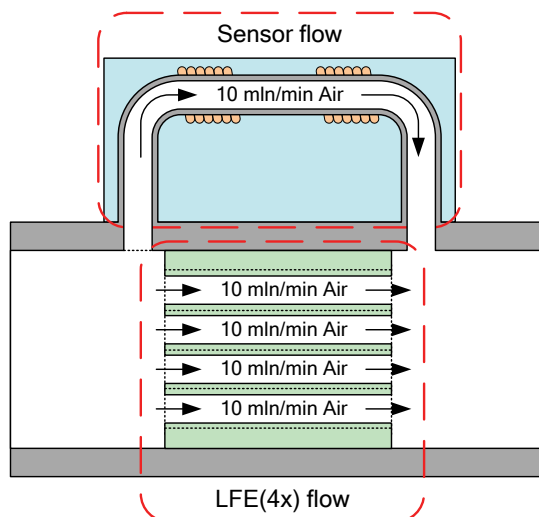

Example of a 50 ml_n/min measurement part

1.7.3 Solenoid Valve Principle

The control valve used in the EL-FLOW *Base* series is a standard, direct operated control valve. It is a normally closed solenoid valve. The plunger is lifted by the force of the magnetic field of the coil. The diameter of the orifice under the plunger is optimised for the customer's application.

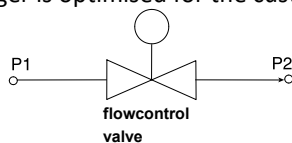

The control valve is not designed to provide positive shut-off. It is recommended to install a separate shut-off valve in the line if so required. Also pressure surges, as may occur during system pressurisation must be avoided.

1.8 Maintenance

No routine maintenance is required to be performed on the controllers when they are used with clean gas.

Units may be flushed with clean, dry inert gas.

In case of severe contamination it may be required to clean the inside of the instrument. After cleaning a recalibration is needed. Bronkhorst® has a trained staff of servicemen available. Contact your local supplier for cleaning and recalibration options.



If the equipment is not properly serviced, serious personal injury and/or damage to the equipment could be the result. It is therefore important that servicing is performed by trained and qualified service personnel.

2 Installation Instructions

2.1 Introduction

This chapter discusses how to prepare the system and install an EL-FLOW *Base* mass flow controller.

2.2 Unpacking and inspection

Check the outside packing box for damage incurred during shipment. Should the packing box be damaged, then the local carrier must be notified at once regarding his liability, if so required. At the same time a report should be submitted to your distributor.

Carefully remove the equipment from the packing box. Verify that the equipment was not damaged during shipment. Should the equipment be damaged, then the local carrier must be notified at once regarding his liability, if so required. At the same time a report should be submitted to your distributor.

Refer to chapter 6, Removal and Return Instructions, about return shipment procedures.



Before installing an EL-FLOW Base it is important to read the attached label and check:

- Flow rate
- Fluid to be measured
- Up- and downstream pressures
- Input/output signal
- Temperature

Do not discard spare or replacement parts with the packing material and inspect the contents for damaged or missing parts.

2.3 Rated pressure test inspection

Each EL-FLOW *Base* is pressure tested to at least 1.5 times the working pressure of the process conditions stipulated by the customer, with a minimum of 8 bar.

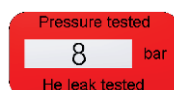

Pressure testing sticker

Each instrument is helium leak tested to at least $2 \cdot 10^{-9}$ mbar l/s Helium outboard.



The tested pressure is stated on the flow controller with a RED COLOURED sticker. Check test pressure before installing in the line.

*If the sticker is **not** available or the test pressure is incorrect, the instrument should **not** be mounted in the process line and be returned to the factory.*

2.4 Instrument mounting

The bottom side of an EL-FLOW *Base* consists of two mounting holes for stable mechanical fixation of the instrument. Refer to the following documents for exact position of the mounting holes.

Dimensional drawing F-201AB, document nr. 7.15.165.

Dimensional drawing F-201CB, document nr. 7.15.166.

Dimensional drawing F-202BB, document nr. 7.15.170.

The preferred mounting position of EL-FLOW *Base* mass flow controllers is horizontal. Other mounting positions may introduce a zero shift and/or little gas and pressure dependency of the zero signal. When

mounting an instrument other than horizontal, zeroing of the instrument is advised. The zeroing procedure is described in chapter 2.12.

Avoid installation in close proximity of mechanic vibration and/or heat sources.

2.5 Fluidic connections

The fluid connections of EL-FLOW *Base* instruments consist of ¼" BSPP female thread. The adapter chambers are optimised for the use of Swagelok RS-type adapters combined with AS013 (70°Sh) o-rings for leak tight installation.



Bronkhorst® highly recommends the use of Swagelok RS-type stainless steel adapters, e.g. part number SS-400-1-4RS.

Adapters can be ordered separately to the instruments. Contact your local distributor for more information.



Always check your system for leaks, before applying fluid pressure. Especially if toxic, explosive or other dangerous fluids are used.

2.6 In-line filter usage

Fluids to be measured should be absolutely free of dirt, oil, moisture and other particles. Fluids that are heavily contaminated or contain particulates are detrimental to precision. If liquid phases enter the sensor chamber, the function of the sensor and the mass flow controller may be impaired.

It is recommended to install an in-line filter or liquid separator upstream of the flow controller, and if backflow can occur, a downstream filter is recommended too. Be aware of the pressure drop caused by the filter.

Contact your distributor for further information.

2.7 Piping requirements

Be sure that piping is absolutely clean!



DO NOT install small diameter piping on high flow rates, because the inlet jet flow will affect the accuracy.

DO NOT mount abrupt angles direct on in- and outlet, especially not on high flow rates. At least 10 pipe diameters distance between the angle and the instrument is recommended.

DO NOT mount pressure regulators direct on the inlet of gas flow meters/controllers, but allow some meters of piping (at least 25 pipe diameters).

2.8 Electrical connections

2.8.1 Interface

EL-FLOW *Base* instruments can be operated by means of:

1. Analog interface (0...5Vdc or 0...10Vdc or 0...20mA or 4...20mA)
2. RS232 interface with FLOW-BUS protocol
3. RS485 interface with Modbus protocol

All above operation options are standard available in EL-FLOW *Base* instruments.

According to the pin-designation both RS232 and RS485 are assigned to the same pins. When connecting these pins to either of the two, the instrument will automatically detect which protocol to use. When sending a frequent request to the instrument, it will be capable of recognising the protocol, once the instrument detect this protocol, it will send an answer.

The instrument will remember the detected protocol as long as the instrument is powered. This auto detection can not be switched off or by-passed.

For electrical hook-up diagrams refer to document 9.16.091, "Hook-up EL-FLOW *Base*"



This documents can be found at:

<http://www.bronkhorst.com/en/downloads>

2.8.2 Power Supply

EL-FLOW *Base* controllers are powered with +15 Vdc to +24 Vdc.

When providing your own power supply be sure that voltage and current rating are according to the specifications of the instrument(s) and furthermore that the source is capable of delivering enough power to the instrument(s). Refer to Hookup EL-FLOW *Base*, document nr. 9.16.091, for more details.

Bronkhorst® recommends the use of their standard cables. These cables have the right connectors and if loose ends are used, these will be marked to prevent wrong connection.

When using other cables, cable wire diameters should be sufficient to carry the supply current and voltage losses must be kept as low as possible. When in doubt: contact your distributor.

EL-FLOW *Base* instruments carry the CE-mark. Therefore they have to comply with the EMC requirements as are valid for these instruments. However compliance with the EMC requirements is not possible without the use of proper cables and connector/gland assemblies.



When connecting the system to other devices (e.g. to PLC), be sure that the integrity of the shielding is not affected. Do not use unshielded wire terminals.

2.9 Power and warm-up

Before switching on power, check if all connections have been made according to the hook-up diagram. It is recommended to turn on power before applying pressure on the instrument and to switch off power after removing pressure. Check fluid connections and make sure there is no leakage. If needed purge the system with a proper fluid. Only purging with gases is allowed. Turn on power and allow at least 30 minutes warming up and stabilizing. During warm-up period, fluid pressure may either be on or off.

2.10 Pressure supply / Start-up

When applying pressure to the system, take care to avoid pressure shocks in the system and increase pressure gradually up to the level of the actual operating conditions.

2.11 System purging

If explosive gases are to be used, purge the process with inert dry gas like Nitrogen, Argon etc. for at least 30 minutes.

In systems with corrosive or reactive fluids, purging with an inert gas is absolutely necessary, because if the tubing has been exposed to air, introducing these fluids will tend to clog up or corrode the system due to a chemical reaction with oxygen or moist air.

Complete purging is also required to remove such fluids from the system before exposing the system to air. It is preferred not to expose the system to air, when working with these corrosive fluids.

2.12 Zeroing

The zero point of each instrument is factory adjusted. However, the zero point may shift slightly due to temperature, pressure, gas type and mounting position influences. If so required, the zero point of the instrument may be re-adjusted.

Zeroing is possible over RS232 Flowbus, RS485 ModBus or by means of using the micro switch. Zeroing by means of using the micro switch is described in this manual.

- Warm-up, pressure up the system and fill the instrument according to the process conditions.
- Make sure no flow is going through the instrument by closing valves near the instrument.
- The setpoint must be zero.
- Press the micro switch and hold it. After a short time the red LED will go ON and OFF, then the green LED will go ON. At that moment release the micro switch.
- The zeroing procedure will start at that moment and the green LED will blink fast. The zeroing procedure waits for a stable signal and saves the zero. If the signal is not stable zeroing will take long and the nearest point to zero is accepted. The procedure will take approx. 10 sec.
- When indication is showing 0% signal and the green indication LED is burning continuously again, then zero has been performed well.

For information how to start the zeroing procedure over RS232 FlowBus or RS485 ModBus check chapter 4.1.4, "Auto Zeroing"

3 Basic Operation

3.1 General

An EL-FLOW *base* instrument can be operated by means of:

- Analog interface (0...5Vdc/0...10Vdc/0...20mA/4...20mA)
- Digital RS232 Flowbus interface (connected to COM-port by means of special cable on 38400 Baud)
- Digital RS485 Modbus interface.

Operation via analog or digital interface can be performed at the same time. A special parameter called "control mode" indicates to which setpoint the controller should respond.

3.2 Analog operation

At analog operation following signals are available:

- measured value (analog output)
- setpoint (analog input)

The type of installed analog interface (0-5V, 0-10V, 0-20mA or 4-20mA) can be found in the model key of the instrument. Refer to paragraph 1.6.2.

Setpoints below 2% of the full scale will be interpreted as 0% setpoint.



When operating the instrument through the analog interface it is possible to connect the instrument simultaneously to RS232 or Modbus/RS485 for reading/changing parameters (e.g. controller response or other fluid selection).

3.3 Digital communication protocol detection (Flow-BUS RS232 or MODBUS RS485)

According to the pin-designation both RS232 and RS485 are assigned to the same pins. At each power-on of the EL-Flow Base instrument the digital communication protocol from the master (PLC/PC) must be detected by the EL-Flow Base instrument. This auto detection cannot be switched off or by-passed.

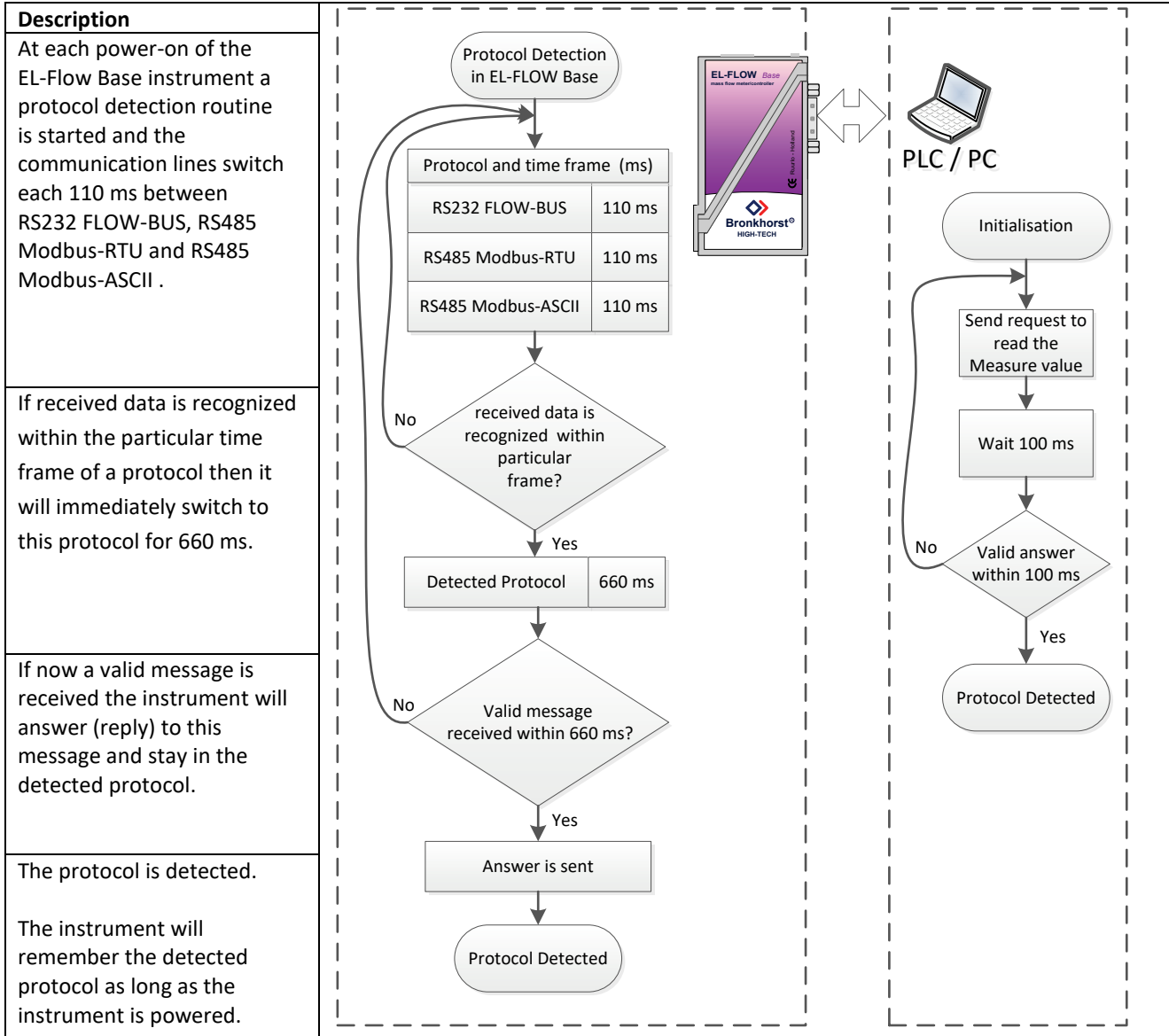

3.4 Basic RS232 Flowbus operation

RS232 Flowbus communication can be used for operating your instrument using the Bronkhorst® FLOWDDE server application.



Physical layer and communication protocol are detected automatically upon reception of messages. These messages must be sent using the correct combination of physical layer and communication protocol. After every power-up the communication detection mode is active.

Dynamic Data Exchange (DDE) provides the user a basic level of inter process communication between Windows applications.

FlowDDE is a DDE server application. Together with a client-application, either self-made or with a SCADA-program from 3rd-parties, it is possible to create an easy way of data exchange between the flow controller and a Windows application.

For example, a cell in Microsoft Excel could be linked to the measured value of the flow controller and when the measured value changes, it will be automatically updated in the Excel spreadsheet.

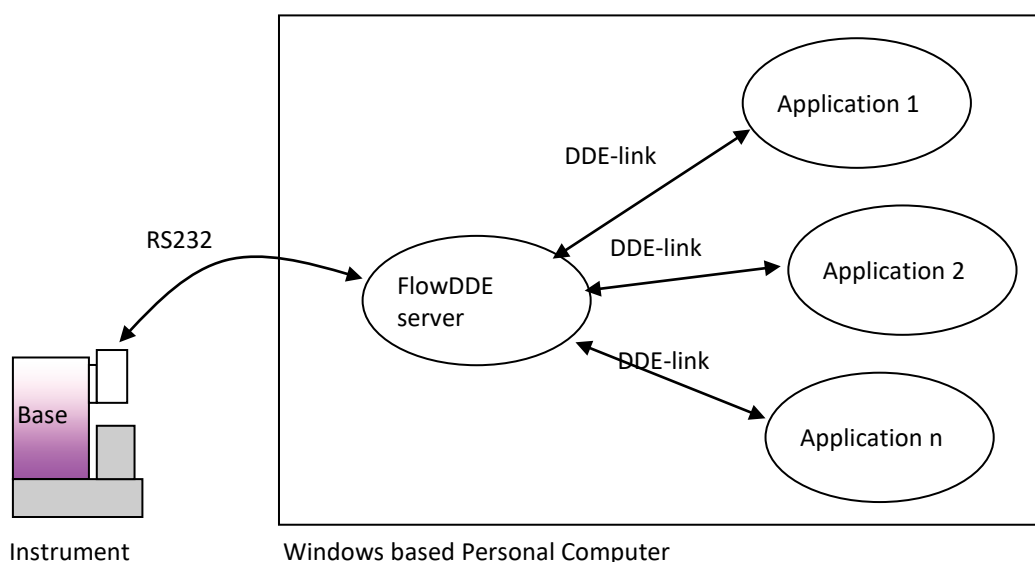

Examples of DDE client applications: FlowPlot, FlowView, MS-Office, LabView, Intouch, Wizcon.

The FLOWDDE server also offers a lot of test facilities and user adjustable settings for efficient communication with the connected flow controller.

How to setup a DDE link with FlowDDE is described in the help-file of the FlowDDE application. Programming examples are available for making applications in: Visual Basic, LabView and Excel.

FlowDDE parameter numbers:

Reading/changing parameter values via FLOWDDE offers the user a different interface to the instrument. Besides the application name: 'FLOWDDE' there is only need of:

- topic, used for channel number: 'C(X)'
- item, used for parameter number: 'P(Y)'

A DDE-parameter number is a unique number in a special FLOWDDE instruments/parameter database and not the same as the parameter number from the process on an instrument.

Node-address and process number will be translated by FLOWDDE to a channel number.



FlowDDE and other Bronkhorst® applications are available at the Bronkhorst download site:
<http://www.bronkhorst.com/en/downloads>



A special RS232 cable (7.03.366) can be ordered separately. It consists of a T-part with 1 male and 1 female sub-D 9 connector on one instrument-side and a normal female sub-D 9 connector on the side of the computer. By means of this cable it is possible to offer RS232 communication and still be able to connect power-supply and analog interface through the (analog) sub-D 9 connector.

3.5 Modbus RS485 operation

This chapter is limited to the description of the interface between the Modbus Mass Flow Controller with a master device. It will explain how to install an EL-FLOW Base instrument to your Modbus system. It only contains the information that is needed most.

The implementation of the Modbus interface is based on the following standards:

- [1] MODBUS Application Protocol Specification V1.1b, December 28, 2006
- [2] MODBUS over Serial Line specification and implementation guide V1.02

There is no mutual communication between Modbus slaves; only between master and slave.



More detailed information about Modbus can be found at <http://www.modbus.org> or any website of the (local) Modbus organisation of your country (when available).



Physical layer and communication protocol are detected automatically upon reception of messages. These messages must be sent using the correct combination of physical layer and communication protocol. After every power-up the communication detection mode is active.

3.5.1 Modbus termination

The Modbus must be terminated correctly with termination resistors (RT1, RT2) and biasing resistors (RB1, RB2).

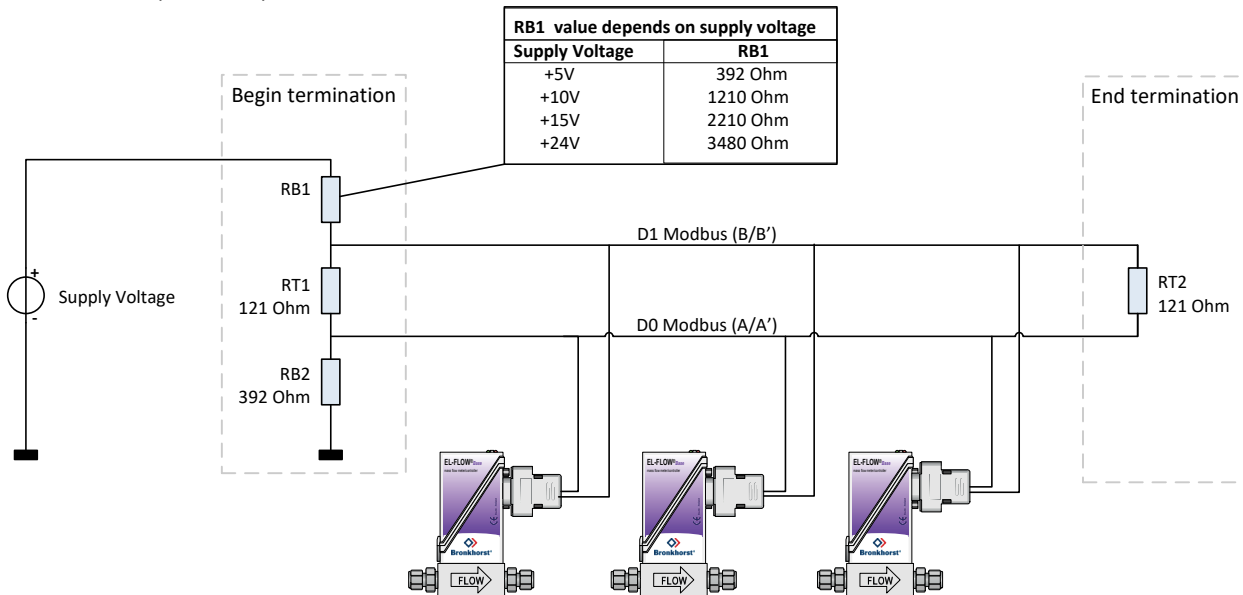

Remark: See hookup diagram for details

Bronkhorst® advises the following resistor values for the following voltages:

Supply voltage termination	Bias Pull-up resistor RB1	Termination resistor RT1 & RT2	Bias Pull-down resistor RB2
+5V	392 Ohm	121 Ohm	392 Ohm
+10V	1210 Ohm	121 Ohm	392 Ohm
+15V	2210 Ohm	121 Ohm	392 Ohm
+24V	3480 Ohm	121 Ohm	392 Ohm

Termination resistors: RT1 and RT2

The termination resistors RT1 and RT2 must be placed only at the extreme ends of the data line (see schematics above). The resistance value should be equal to the characteristic cable impedance. In case of common cabling this should be:

$$RT1 = 121 \text{ Ohm}$$

$$RT2 = 121 \text{ Ohm}$$

Remark: RT1 and RT2 should be larger than 90 Ohm.

Biasing resistors: RB1 and RB2

The biasing resistors RB1 (pull-up) and RB2 (pull-down) must be added.

RB1 must be connected between the Supply Voltage (U_s) and D1 Modbus (B/B'). The resistance value of RB1 depends on the applied supply voltage, and is:

$$RB1 (U_s = +24V) = 3480 \text{ Ohm}$$

$$RB1 (U_s = +15V) = 2210 \text{ Ohm}$$

$$RB1 (U_s = +10V) = 1210 \text{ Ohm}$$

$$RB1 (U_s = +5V) = 392 \text{ Ohm}$$

RB2 must be connected between the D0 Modbus (A/A') and ground. The resistance value of RB2 is:

$$RB2 = 392 \text{ Ohm}$$

3.5.2 Slave address, baud rate and parity setup

Default instruments will be delivered to customers on address 1 and with a baud rate of 19200 baud and EVEN parity.

The slave address, baud rate and parity of the Bronkhorst® meter/controller Modbus slave can be changed to fit the instrument in your existing Modbus network. Changing the slave address, baud rate and parity can be done in the following ways.

Using RS232: FlowDDE

'Off-line' via the RS232 communication port by means of FlowDDE. This program can be used to read/change parameters, including the slave address, baud rate and parity.

Connect your Bronkhorst® meter/controller Modbus slave instrument to a free COM-port using the special cable with on one side a T-part with male and female sub-D 9 connector and on the other side a female sub-D 9 connector (part number 7.03.366). The single sub-D 9 connector should be connected to your COM-port and the female sub-D 9 of the T-part to the male sub-D 9 of the instrument. Standard cables are approx. 3 meters. Maximum length between PC and instrument allowed is approximately 10 meters.

Start FlowDDE and open communication via the menu (as shown below) or by pressing <F3>.

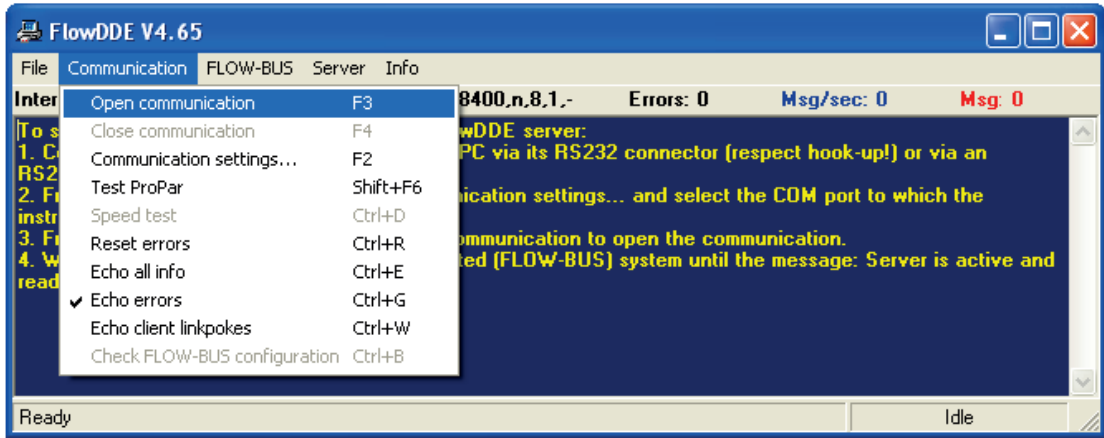

Once the DDE server is active, open the FlowDDE Test Form via the menu (as shown below) or by pressing <F6>.

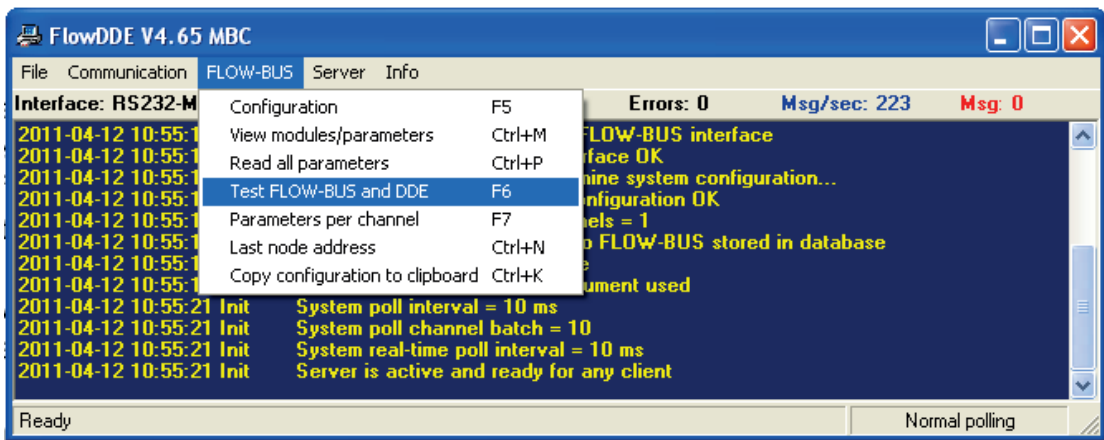

The following screen appears:

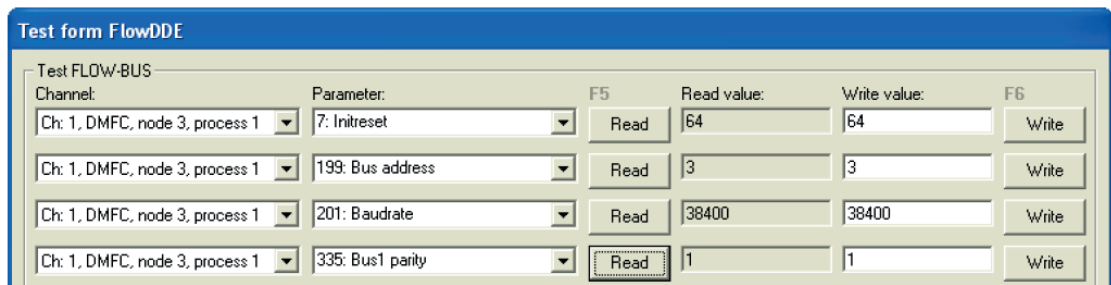

To read/change the slave address, parameter 199: Bus address must be selected. To read/change the baud rate, parameter 201: Baudrate must be selected. And to read/change the parity parameter 335: Bus1 Parity must be selected. To change one of these parameters parameter 7: Initreset has to be set to '64' first.

Valid values for the slave address are between 1 and 247, valid values for the baud rate are 9600, 19200 and 38400, valid values for parity are 0 (= None), 1 (= Odd) and 2 (= Even). The changed values will be effective immediately after changing.

In case of OEMD2 hardware revision (Read parameter "326 Hardware platform id". If this parameter is available and has value 251 it is an OEMD2):

To read/change the slave address, parameter "309: Fieldbus2 address" must be selected. To read/change the baud rate, parameter "310: Fieldbus2 baudrate" must be selected. And to read/change the parity parameter "336: Fieldbus2 parity" must be selected". To change one of these parameters parameter "7: Initreset" has to be set to '64' first.

Test form FlowDDE

Test FLOW-BUS

Channel:	Parameter:	F5	Read value:	Write value:	F6
Ch: 1, DMFC, node 3, process 1	7: Initreset	Read	64	64	Write
Ch: 1, DMFC, node 3, process 1	309: Fieldbus2 address	Read	1	1	Write
Ch: 1, DMFC, node 3, process 1	310: Fieldbus2 baudrate	Read	19200	19200	Write
Ch: 1, DMFC, node 3, process 1	336: Fieldbus2 parity	Read	2	2	Write

Valid values for the slave address are between 1 and 247, valid values for the baud rate are 9600, 19200 and 38400, valid values for parity are 0 (= None), 1 (= Odd) and 2 (= Even). The changed values will be effective immediately after changing.

Using micro-switch and LEDs on top of the instrument

Readout bus-address/MAC-ID and baud rate:

Pressing the switch 3x briefly with intervals of max. 1 second in normal running/operation mode will trigger the instrument to “show” its bus-address/MAC-ID and baud rate.

For indication the bus-address/MAC-ID the green LED will flash the amount of tens and the red LED the amount of units in the number. For indication of baud rate setting, both LEDs will flash. The flashes are called “count-flashes” and have a pattern of 0.5 sec. on, 0.5 sec. off.

Table: LED indications for bus-address and baud rate

Green LED	Red LED	Time	Indication
amount of count flashes (0...12)	Off	0 ... 12 sec. Maximum	tens in bus-address for instrument
Off	Amount of count flashes (0...9)	0 ... 9 sec. Maximum	units in bus-address for instrument
amount of count flashes (1...3)	amount of count flashes (1...3)	1 ... 3 sec. Maximum	baud rate setting for instrument 1 = 9600 Baud 2 = 19200 Baud 3 = 38400 Baud

Note: Value zero will be indicated by a period of 1 sec. off (0.5 sec. off + 0.5 sec. off).

Examples:

- For bus-address 35 / 9600 baud the green LED will flash 3 times, the red LED will flash 5 times and both LEDs will flash 1 time.
- For bus-address 20 / 19200 baud the green LED will flash 2 times, the red LED will flash 0 times and both LEDs will flash 2 times.
- For bus-address 3 / 38400 the green LED will flash 0 times, the red LED will flash 3 times and both LEDs will flash 3 times.

Change bus-address/MAC-ID and baud rate:

Pressing the switch 5x briefly with intervals of max. 1 second in normal running/operation mode will trigger the instrument to enter the bus configuration mode.

Within the time-out period of 60 sec. it is possible to start changing the bus-address/MAC-ID of the instrument (see table below).

Table 7: Procedure for changing bus-address and baud rate

Step	Action	Indication	Time	Handling
1	Set instrument to "bus config mode"	both LEDs off		Press switch 5x briefly
2	Set tens of bus-address	Green LED flashes 0.1 sec on, 0.1 sec off count-flashes start when switch is pressed: 0.5 sec on, 0.5 sec off	time-out: 60 sec	Press switch and count green flashes for tens of bus-address. Release when wanted amount has been count. Counts up to max. 12 and than starts at 0 again. When counting fails, keep switch pressed and restart counting for next attempt.
3	Set units of bus-Address	red LED flashes 0.1 sec on, 0.1 sec off count-flashes start when switch is pressed: 0.5 sec on, 0.5 sec off	time-out: 60 sec	Press switch and count red flashes for units of bus-address/MAC-ID. Release when wanted amount has been count. Counts up to max. 9 and then starts at 0 again. When counting failed, keep switch pressed and restart counting for next attempt.
4	Set baud rate of field bus communication. 1 = 9600 Baud 2 = 19200 Baud 3 = 38400 Baud	both red and green LED flashes 0.1 sec on, 0.1 sec off count-flashes start when switch is pressed: 0.5 sec on, 0.5 sec off	time-out: 60 sec	Press switch and count red and green flashes for baud rate setting. Release when wanted amount has been count. Counts up to max. 3 and than starts at 0 again. When counting failed, keep switch pressed and restart counting for next attempt. Note: selection of 0 means: No change

Instrument returns to normal running/operation mode.

Changes are valid when they are made within the time-out times.

Actual setting can be checked by pressing the switch 3x briefly with intervals of max. 1 sec. for readout the bus-address/MAC-ID and baud rate.

Note 1:

Value zero will be indicated by a period of 1 sec. off (0.5 sec. off + 0.5 sec. off).

When value zero is wanted, press switch shortly and release it again within 1 sec.

Note 2:

Before each action of flash-counting, the LED(s) to be used for counting will flash in a high frequency. (Pattern: 0.1 sec on, 0.1 sec off). As soon as the switch is pressed-down, this LED (or both LEDs) will be off and the counting sequence will start.

Note 3: The parity setting cannot be read or changed using the micro-switch.

3.5.3 Implementation class

The physical and data link layer are implemented conforming to the "basic slave" implementation class as described in document [2], "MODBUS over Serial Line specification and implementation guide V1.02". The following options have been implemented:

Parameter	Options	Remarks
Addressing	address configurable from 1 to 247 (default 1)	see section 3.5.1
broadcast support	Yes	
baud rate	9600, 19200 (default), 38400	see section 3.5.1
parity	None, Odd, Even (default)	see section 3.5.1
transmission mode	RTU/ASCII	Auto detection
data bits	RTU=8, ASCII=7	not configurable
electrical interface	RS485 2W-cabling	See document: 9.16.091 - Hook-up diagram EL-FLOW <i>Base</i>
connector type	DB9 Male	See document: 9.16.091 - Hook-up diagram EL-FLOW <i>Base</i>



More detailed information about Modbus can be found at <http://www.modbus.org> or any website of the (local) Modbus organisation of your country (when available).

3.5.4 Response time

This slave device will respond on each valid request from the master within 100 msec. This means that the response timeout setting of the master should be set to a value larger than or equal to 100 ms.

3.5.5 Supported Modbus functions

This section describes the supported Modbus function codes. Refer to document [1] "MODBUS Application Protocol Specification V1.1b, December 28, 2006" for more details.



More detailed information about Modbus can be found at <http://www.modbus.org> or any website of the (local) Modbus organisation of your country (when available).

Read Holding Registers (03)

Possible exception responses:

- 02, ILLEGAL DATA ADDRESS, in case of reading of non-existing address, or reading a part of a multiregister parameter (float, long, etc)
- 03, ILLEGAL DATA VALUE, in case of reading less than 1 or more than 125 registers
- 04, SLAVE DEVICE FAILURE, in case of reading a write-only register



The maximum message size for the Read Holding Registers function is 100 bytes at 9600 baud (200 bytes at 19200 baud and 400 bytes at 38400 baud). When this size is exceeded, corrupted responses may be received.

Write Single Register (06)

Possible exception responses:

- 02, ILLEGAL DATA ADDRESS, in case of writing to non-existing address, or writing to a part of a multiregister parameter (float, long, etc)
- 04, SLAVE DEVICE FAILURE, in case of writing to read-only register
- 04, SLAVE DEVICE FAILURE, in case of writing illegal value to register

Write Multiple Registers (16)

Possible exception responses:

- 02, ILLEGAL DATA ADDRESS, in case of writing to non-existing address, or writing to a part of a multiregister parameter (float, long, etc)

- 03, ILLEGAL DATA VALUE, in case of reading less than 1 or more than 123 registers
- 04, SLAVE DEVICE FAILURE, in case of writing to read-only register
- 04, SLAVE DEVICE FAILURE, in case of writing illegal value to register

When one of the written registers raises an exception, the value written to all subsequent registers are discarded (ignored).

Diagnostics (08)

The following sub-functions are supported:

Sub-function code (dec)	Name
00	Return Query Data
10	Clear Counters and Diagnostics Register
11	Return Bus Message Count
12	Return Bus Communication Error Count
13	Return Bus Exception Error Count
14	Return Slave Message Count
15	Return Slave No Response Count
16	Return Slave NAK Count (always 0)
17	Return Slave Busy Count (always 0)
18	Return Bus Character Overrun Count



The maximum message size for the Return Query Data sub function is 100 bytes at 9600 baud (200 bytes at 19200 baud and 400 bytes at 38400 baud). When this size is exceeded, corrupted responses may be received.

Possible exception responses:

- 01, ILLEGAL FUNCTION, in case of not-supported sub-function
- 03, ILLEGAL DATA VALUE, in case of an incorrect value for the data field

Report Slave ID (17)

The Slave ID field in the response is a string with the same contents as FlowDDE parameter 1 (indent number + version nr/serial nr). The Run Indicator Status field in this message will indicate ON when the device is in normal operating mode (FB_NORMAL).

Possible exception responses:

- 04, SLAVE DEVICE FAILURE, in case of an internal error

3.5.6 Available parameters

Modbus registers (in the data model) are numbered from 1 to 65536. In a Modbus PDU (Protocol Data Unit) these registers are addressed from 0 to 65535.

The following table lists the most commonly used parameters.

PARAMETER NAME	PARAMETER TYPE	ACCESS	MODBUS REGISTERS				REMARK
			PDU ADDRESS		REGISTER NUMBER		
			Hex	Dec	Hex	Dec	
Wink	Unsigned char	W	0x0000	0	0x0001	1	Value 14592
Initreset	Unsigned char	RW	0x000A	10	0x000B	11	
Valve output	Unsigned int	RW	0x001F	31	0x0020	32	0..32767
Measure	Unsigned int	R	0x0020	32	0x0021	33	
Setpoint	Unsigned int	RW	0x0021	33	0x0022	34	
Setpoint slope	Unsigned int	RW	0x0022	34	0x0023	35	
Analog input	Unsigned int	R	0x0023	35	0x0024	36	
Control mode	Unsigned char	RW	0x0024	36	0x0025	37	
Sensor type	Unsigned char	RW	0x002E	46	0x002F	47	
Capacity unit index	Unsigned char	RW	0x002F	47	0x0030	48	
Fluid number	Unsigned char	RW	0x0030	48	0x0031	49	
Alarm info	Unsigned char	R	0x0034	52	0x0035	53	
Temperature	Unsigned int	R	0x0427	1063	0x0428	1064	See addr 0xA138
Identification number	Unsigned char	RW	0x0E2C	3628	0x0E2D	3629	
Normal step c. resp.	Unsigned char	RW	0x0E45	3653	0x0E46	3654	

PARAMETER NAME	PARAMETER TYPE	ACCESS	MODBUS REGISTERS				REMARK
			PDU ADDRESS		REGISTER NUMBER		
			Hex	Dec	Hex	Dec	
Stable situation c. resp.	Unsigned char	RW	0x0E51	3665	0x0E52	3666	
Open from zero c. resp.	Unsigned char	RW	0x0E52	3666	0x0E53	3667	
Calibration mode	Unsigned char	RW	0x0E61	3681	0x0E62	3682	
Monitor mode	Unsigned char	RW	0x0E62	3682	0x0E63	3683	
Reset	Unsigned char	W	0x0E68	3688	0x0E69	3689	
Fieldbus2 address	Unsigned char	RW	0x0F8A	3978	0x0F8B	3979	Modbus address OEMD2
Fieldbus2 parity	Unsigned char	RW	0x0F8C	3980	0x0F8D	3981	Modbus parity OEMD2
Fieldbus1 address	Unsigned char	RW	0x0FAA	4010	0x0FAB	4011	Modbus address
Fieldbus1 parity	Unsigned char	RW	0x0FAC	4012	0x0FAD	4013	Modbus parity
Sensor differentiator dn	Float	RW	0x8158..0x8159	33112..33113	0x8159..0x815A	33113..33114	
Sensor differentiator up	Float	RW	0x8160..0x8161	33120..33121	0x8161..0x8162	33121..33122	
Capacity 100%	Float	RW	0x8168..0x8169	33128..33129	0x8169..0x816A	33129..33130	
Fluid name	String (10 bytes)	RW	0x8188..0x818C	33160..33164	0x8189..0x818D	33161..33165	
Capacity unit	String (7 bytes)	RW	0x81F8..0x81FB	33272..33275	0x81F9..0x81FC	33273..33276	
Fmeasure	Float	R	0xA100..0xA101	41216..41217	0xA101..0xA102	41217..41218	
FSetpoint	Float	RW	0xA118..0xA119	41240..41241	0xA119..0xA11A	41241..41242	
Temperature	Float	R	0xA138..0xA139	41272..41273	0xA139..0xA13A	41273..41274	See addr 0x0427
Capacity 0%	Float	RW	0xA1B0..0xA1B1	41392..41393	0xA1B1..0xA1B2	41393..41394	
Device type	String (6 bytes)	R	0xF108..0xF10A	61704..61706	0xF109..0xF10B	61705..61707	
BHTModel number	String (14 bytes)	RW	0xF110..0xF116	61712..61718	0xF111..0xF117	61713..61719	
Serial number	String (16 bytes)	RW	0xF118..0xF11F	61720..61727	0xF119..0xF120	61721..61728	
Customer model	String (16 bytes)	RW	0xF120..0xF127	61728..61735	0xF121..0xF128	61729..61736	
Firmware version	String (5 bytes)	R	0xF128..0xF12A	61736..61738	0xF129..0xF12B	61737..61739	
Usertag	String (13 bytes)	RW	0xF130..0xF136	61744..61750	0xF131..0xF137	61745..61751	
Valve output	Unsigned long	RW	0xF208..0xF209	61960..61961	0xF209..0xF20A	61961..61962	
PID-Kp	Float	RW	0xF2A8..0xF2A9	62120..62121	0xF2A9..0xF2AA	62121..62122	
PID-Ti	Float	RW	0xF2B0..0xF2B1	62128..62129	0xF2B1..0xF2B2	62129..62130	
PID-Td	Float	RW	0xF2B8..0xF2B9	62136..62137	0xF2B9..0xF2BA	62137..62138	
Density actual	Float	R	0xF478..0xF479	62584..62585	0xF479..0xF47A	62585..62586	
Dynamic display factor	Float	RW	0xF508..0xF509	62728..62729	0xF509..0xF50A	62729..62730	
Static display factor	Float	RW	0xF510..0xF511	62736..62737	0xF511..0xF512	62737..62738	
Exponential smoothing	Float	RW	0xF520..0xF521	62752..62753	0xF521..0xF522	62753..62754	
Fieldbus2 baudrate	Long integer	RW	0xFD48..0xFD49	64584..64585	0xFC49..0xFC4A	64585..64586	Modbus baudrate OEMD2
Fieldbus1 baudrate	Long integer	RW	0xFD48..0xFD49	64840..64841	0xFD49..0xFD4A	64841..64842	Modbus baudrate

Notes:

- Access indicates whether parameter can be Read and/or Written.
- When a byte parameter is read, the upper 8-bits of the Modbus register will be 0. When a byte parameter is written, the upper 8-bits must be set to 0.
- Long integer parameters have a length of 4 bytes and are mapped on two consecutive Modbus registers. The first register contains bit 32-16, the second register contains bit 15-0.
- Floating point parameters have a length of 4 bytes and are mapped on two consecutive Modbus registers. Floats are in single precision IEEE format (1 sign bit, 8 bits exponent and 23 bits fraction). The first register contains bit 32-16, the second register contains bit 15-0.
- String parameters can have a length of maximal 16 bytes and can take up to 8 Modbus registers where each register contains two characters (bytes). The upper byte of the first register contains the first character of the string. When writing strings, the write action should always start from the first register as a complete block (it is not possible to write a part of a string). If the string is shorter than the specified maximum length the string should be terminated with a 0.



Details and meaning can be found in document 9.17.023 Operation instructions digital instruments.

This document can be found at:

http://www.bronkhorst.com/en/downloads/instruction_manuals/

3.6 Push-button operation

By means of manual operation of the micro push-button switch some important actions for the instrument can be selected/started. These options are available in both analog and digital operation mode.

LED's		Time Pushed	Indication
Green	Red		
Off	Off	0 – 1 sec	Pressing a switch shortly by accident will not cause unwanted reactions of instrument. Pressing the switch 3x briefly with intervals of max. 1 sec. will force instrument to indicate its bus-address/MAC-ID and evt. baud rate. Check chapter 3.55, "Modbus RS485 operation" for more details.
Off	Off	1 – 4 sec	
Off	On	4 – 8 sec	Reset instrument Instrument program will be restarted and all warning and error message will be cleared During (new) start-up instrument will perform a (new) self-test
On	Off	8 – 12 sec	Auto-zero Instrument will be re-adjusted for measurement of zero-flow (not for pressure meter/controller) NOTE: First make sure there is no flow and instrument is connected to power for at least 30 minutes!
On	On	12 – 16 sec	Prepare instrument for FLASH mode for firmware update. Instrument shuts down and both LEDs turn off. At next power-up instrument will be active again.

LED indications using micro-switch at normal running mode of an instrument

LED's		Time Pushed	Indication
Green	Red		
off	Off	0 – 4 sec	No action Pressing a switch shortly by accident will not cause unwanted reactions of the instrument
off	normal flash	4 – 8 sec	Restore parameters All parameter settings (except field bus settings) will be restored to situation of final test at BHT production
normal flash	Off	8 – 12 sec	No action
normal flash	normal flash	12 – 16 sec	Manual install. The bus address and baudrate can be changed by means of micro-switch en LEDs. The procedure is described in 3.5.1 (<i>Change bus-address/MAC-ID and baud rate</i>).

LED indications using micro-switch at power-up situation of an instrument

3.7 Micro-switch use for reading/changing control mode

3.7.1 Read control mode

For switching between different functions in use of a digital meter or controller several modes are available. More information about the available control modes can be found at parameter "Control mode".

Pressing the switch 2x briefly with intervals of max. 1 second in normal running/operation mode will trigger the instrument to "show" its control mode. For indication of the control mode number the green LED will flash the amount of tens and the red LED the amount of units in the number. The flashes are called "count-flashes" and have a pattern of 0.5 sec. on, 0.5 sec. off. The control mode numbers can be found at parameter "control mode"

View current control mode (press switch 2x briefly)			
LED's		Time	Indication
Green	Red		
amount of count flashes (0...2)	off	0 ... 2 sec. maximum	tens in control mode number
off	amount of count flashes (0...9)	0 ... 9 sec. maximum	units in control mode number



Value zero will be indicated by a period of 1 sec. off (0.5 sec. off + 0.5 sec. off).

3.7.2 Change control mode:

For switching between different functions in use of a digital meter or controller several modes are available. More information about the available control modes can be found at parameter "Control mode".

Pressing the switch 4x briefly with intervals of max. 1 second in normal running/operation mode will trigger the instrument to "change" its control mode.

Change current control mode (press switch 4x briefly)				
Step	Action	Indication	Time	Handling
1	Set tens of setpoint / control mode number	<p>● green LED flashes 0.1 sec on 0.1 sec off</p> <p>Count-flashes start when switch is pressed: 0.5 sec on 0.5 sec off</p>	time-out: 60 sec	<p>Press switch and count green flashes for tens of control mode number. Release when wanted amount has been count.</p> <p>Counts up to max. 2 and then starts at 0 again. When counting fails, keep switch pressed and restart counting for next attempt.</p>
2	Set units of setpoint / control mode number	<p>● red LED flashes 0.1 sec on 0.1 sec off</p> <p>Count-flashes start when switch is pressed: 0.5 sec on 0.5 sec off</p>	time-out: 60 sec	<p>Press switch and count red flashes for units of control mode number. Release when wanted amount has been count.</p> <p>Counts up to max. 9 and then starts at 0 again. When counting failed, keep switch pressed and restart counting for next attempt.</p>

Instrument returns to normal running/operation mode.

Changes are valid when they are made within the time-out times.

See parameter 'Control mode' for behaviour at power-up of the instrument.



Value zero will be indicated by a period of 1 sec. off (0.5 sec. off + 0.5 sec. off).
When value zero is wanted, press switch shortly and release it again within 1 sec.



Before each action of flash-counting, the LED's to be used for counting will flash in a high frequency.
(Pattern: 0.1 sec on, 0.1 sec off). As soon as the switch is pressed-down, this LED (or both LED's) will be off and the counting sequence will start.

3.8 LED indications

LED's		Time	Indication
Green	Red		
slow wink		0.2 sec on, 0.2 sec off	Wink mode By a command send to the instrument.
fast wink		0.1 sec on, 0.1 sec off	Switch-released, selected action started.

Green and Red LED turn-by-turn indication modes (no switch used)

Green LED	Time	Indication
Off	Continuously	Power-off or program not running
On	Continuously	Normal running/operation mode
Flash	0.2 sec on, 0.2 sec off	Special function mode Instrument is busy performing any special function. E.g. auto-zero or self-test

Green LED indication modes (no switch used)

Red LED	Time	Indication
Off	Continuously	No error
Flash	Variable	Bus activity on the Modbus interface
On	Continuously	Critical error message A serious error occurred in the instrument Instrument needs service before further using

Red LED indication modes (no switch used)

3.9 Basic Parameters and Properties

3.9.1 Introduction

Every parameter has its own properties. These properties are given in a table as shown:

Type	Access	Range	FlowDDE	FlowBus	ModBus
[type]	RW 	[x]...[y]	[FB]	[Pro]/[Par]	[address]/[index]

Type

Unsigned char	1 byte character
Unsigned char[x]	x byte array (string)
Unsigned int	2 byte unsigned integer
Float	4 byte floating point

Access

R	The parameter is read-only
RW	The parameter can be read and write
RW 	The parameter can only be written when the Init Reset parameter is set to 64. See Chapter 4.1.1, General Product Information for more details.

Range

Some parameters only accept values within a certain range:

[x]	Minimal value of the range.
[y]	Maximal value of the range.

FlowDDE

Parameter number in FlowDDE. Check chapter **Error! Reference source not found.**4, “**Error! Reference source not found.**”, for detailed information.

FlowBus

Process and parameter number to address parameters using the FlowBus protocol.

[Pro]	Flowbus process number
[Par]	Flowbus parameter number

Check document 9.17.027 , “RS232 interface with FLOW-BUS protocol”, for detailed information.

ModBus

PDU Address and register number to address parameters using the ModBus protocol.

[address]	Hexadecimal PDU address .
[index]	Decimal register number.

For the ModBus protocol every 2 bytes are addressed separately. Check chapter 3.55, “Modbus RS485 operation” for more details.

3.9.2 Basic Parameters

Measure

<i>Type</i>	<i>Access</i>	<i>Range</i>	<i>FlowDDE</i>	<i>FlowBus</i>	<i>ModBus</i>
Unsigned int	R	0...41942	8	1/0	0x0020/33

The measured value indicates the amount of mass flow metered by the instrument. The signal of 0...100% will be presented in a range of 0...32000. The maximum signal to be expected is 131.07 %, which is: 41942.

Setpoint

<i>Type</i>	<i>Access</i>	<i>Range</i>	<i>FlowDDE</i>	<i>FlowBus</i>	<i>ModBus</i>
Unsigned int	RW	0...32000	9	1/1	0x0021/34

Setpoint is used to set the wanted amount of mass flow. Signals are in the same range as the measured value, only setpoint is limited between 0 and 100 %.

Control Mode

<i>Type</i>	<i>Access</i>	<i>Range</i>	<i>FlowDDE</i>	<i>FlowBus</i>	<i>ModBus</i>
Unsigned int	RW	0...18	12	1/4	0x0024/37

The Controller mode is used to select different functions of the instrument. The following modes are available:

Value	Mode	Instrument action	Setpoint source
0	DIGITAL_INPUT	Controlling	RS232/RS485
1	ANALOG_INPUT	Controlling	Analog input
3	VALVE_CLOSE	Valve closed	
4	CONTROLLER_IDLE	Idle	
5	TEST_MODE	Test mode enabled	
7	SETPOINT_100	Controlling @100%	Fixed 100%
8	VALVE_OPEN	Valve full opened	
9	CALIBRATION_MODE	Calibration mode enabled	
12	SETPOINT_0	Controlling @0%	Fixed 0%
18	RS232_INPUT	Controlling	RS232 FlowBus

After power-up the control mode will always be set to DIGITAL_INPUT or ANALOG_INPUT, depending on customer's requirement. Check chapter 4.1.6, Changing Default Control Mode, to change the start-up mode.

4 Advanced Operation

4.1 Reading and Changing Instrument Parameters

4.1.1 Introduction



All parameters described in this chapter have influence on the behaviour of the mass-flow meter. Please be aware that wrong settings can disorder the output and control response. To avoid un-careless changes of these parameters, these parameters are locked. To un-lock these parameters use set parameter "Init Reset" to "UN-LOCKED"

Initreset

Type	Access	Range	FlowDDE	FlowBus	ModBus
Unsigned char	RW	82/64	7	0/10	0x000A/11

The Initreset parameter is used to 'Un-Lock' advanced parameters for writing. This parameter knows the following values:

Value	Mode	Instrument action
82	LOCKED	Advanced parameters are read-only
64	UN_LOCKED	Advanced parameters are write- en readable.

This parameter is always set to "LOCKED" at power-up.

4.1.2 Identification

Serial number

Type	Access	Range	FlowDDE	FlowBus	ModBus
Unsigned char[20]	R	-	92	113/3	0xF118..0xF11F/61721..61728

This parameter consists of a maximum 20-byte string with instrument serial number for identification. Example: "M0202123A"

BHT Model number

Type	Access	Range	FlowDDE	FlowBus	ModBus PDU
Unsigned char[14]	R	-	91	113/2	0xF111..0xF117/61713..61719

Bronkhorst® instrument model number information string.

Firmware version

Type	Access	Range	FlowDDE	FlowBus	ModBus PDU
Unsigned char[5]	R	-	105	113/5	0xF128..0xF12A/61737..61739

Revision number of firmware. Eg. "V1.12"

Usertag

Type	Access	Range	FlowDDE	FlowBus	ModBus PDU
Unsigned char[13]	RW 	-	115	113/6	0xF130..0xF136/61745..61751

User definable alias string. Maximum 13 characters allow the user to give the instrument his own tag name.

Customer model

Type	Access	Range	FlowDDE	FlowBus	ModBus PDU
Unsigned char[16]	RW 	-	93	113/4	0xF120..0xF127/61729..61736

Digital instrument manufacturing configuration information string.

This string can be used by Bronkhorst® to add extra information to the model number information.

4.1.3 Fluid Information

Next parameters give information about the fluid range of the instrument.

Fluid name

Type	Access	Range	FlowDDE	FlowBus	ModBus PDU
Unsigned char[10]	RW 	-	25	1/17	0x8188..0x818C/33161..33165

Fluid name consists of the name of the fluid. Up to 10 characters are available for storage of this name.

Fluid unit

Type	Access	Range	FlowDDE	FlowBus	ModBus PDU
Unsigned char[7]	R	-	129	1/31	0x81F8..0x81FB/33273..33276

The Fluid unit can be read by parameter 'capacity unit'. This parameter contains the unit in maximal 7 characters.

Capacity 100%

Type	Access	Range	FlowDDE	FlowBus	ModBus PDU
Float	R	±1E-10... ±1E+10	21	1/13	0x8168..0x8169/33129..33130

Capacity is the maximum value (span) at 100% for direct reading in sensor base units.

Capacity 0%

Type	Access	Range	FlowDDE	FlowBus	ModBus PDU
Float	R	±1E-10... ±1E+10	183	33/22	0xA1B0..0xA1B1/41393..41394

This is the capacity zero point (offset) for direct reading in sensor base units.

4.1.4 Auto Zeroing

To start the auto zero-procedure two parameters should be written:

Control Mode

Type	Access	Range	FlowDDE	FlowBus	ModBus
Unsigned int	RW	0...18	12	1/4	0x0024/37

Check chapter 3.9.2, "Basic Parameters", for available control modes.

Calibration Mode

Type	Access	Range	FlowDDE	FlowBus	ModBus
Unsigned int	RW 	9	58	115/1	0x0E61/3682

Value	Mode	Instrument action
0	IDLE	Idle
9	AUTO_ZERO	Auto-zeroing
255	ERROR	Idle

Procedure:

Step 1: Set Control Mode to CALIBRATION_MODE (9)

Step 2: Set Calibration Mode to AUTO_ZERO(9)

Step 3: Check Calibration Mode,

IDLE	Auto-zeroing succeeded
AUTO_ZERO	Auto-zeroing active
ERROR	Auto-zeroing failed

4.1.5 Controller Response Adjustment

The controller settling time of EL-FLOW *Base* instruments is factory adjusted to approximately 1 second at customer process conditions.

When real process conditions differ from supplied data, or when a faster or slower controller response is needed, a readjustment can be performed.



Settling time is defined as the time to reach the setpoint (and stay) within ±2% of the initial setpoint

The picture below shows the basic controller diagram of the EL-FLOW *Base*. It consists of a standard PID controller with a number of add-ons.

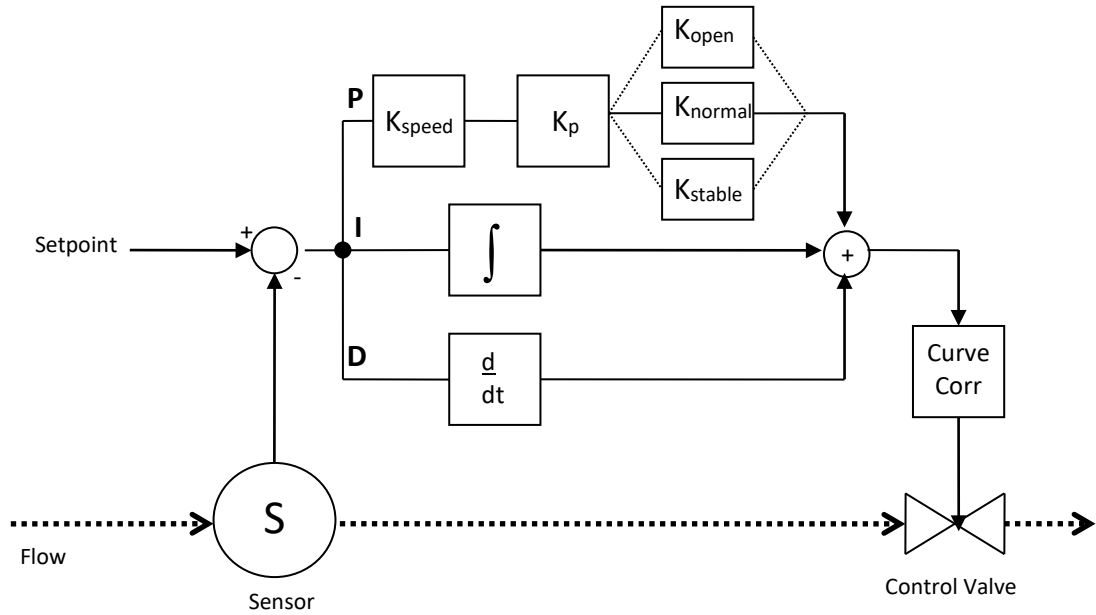

Basically, when a faster or slower controller response is needed, only the controller gain *Kspeed* or *Kp* has to be changed.

Kp (PID-Kp)

Type	Access	Range	FlowDDE	FlowBus	ModBus PDU
Float	RW	0...1E+10	167	114/21	0xF2A8..0xF2A9/62121..62122

Proportional action of the PID controller.

Kspeed

Type	Access	Range	FlowDDE	FlowBus	ModBus PDU
Float	RW	0...1E+10	254	114/1	0xF2F0..0xF2F1/62193..62194

Ti (PID-Ti)

Type	Access	Range	FlowDDE	FlowBus	ModBus PDU
Float	RW	0...1E+10	168	114/22	0xF2B0..0xF2B1/62129..62130

Integration action in seconds of the PID controller.

The value should not be changed.

Td (PID-Td)

Type	Access	Range	FlowDDE	FlowBus	ModBus PDU
Float	RW	0...1E+10	169	114/23	0xF2B8..0xF2B9/62137..62138

Differentiation action in seconds of the PID controller.

Default Value: 0.0

This value should not be changed.

Kopen (Open from zero c. resp.)

Type	Access	Range	FlowDDE	FlowBus	ModBus PDU
Unsigned char	RW 	0...255	165	114/18	0x0E52/3667

Controller response when starting-up from 0% (when valve opens).

Value 128 is default and means: no correction.

Otherwise controller speed will be adjusted as follows:

$$response_new = response_old \cdot \frac{(128 - respopen0)}{1.05}$$

Knormal (Normal step c. resp.)

Type	Access	Range	FlowDDE	FlowBus	ModBus PDU
Unsigned char	RW 	0...255	72	114/5	0x0E45/3654

Controller response during normal control (at setpoint step)

Value 128 is default and means: no correction.

Otherwise controller speed will be adjusted as follows:

$$response_new = response_old \cdot \frac{(128 - contresp)}{1.05}$$

Kstable (Stable situation c. resp.)

Type	Access	Range	FlowDDE	FlowBus	ModBus PDU
Unsigned char	RW 	0...255	141	114/17	0x0E51/3666

Controller response when controller is stable (within band of 2% of setpoint)

Value 128 is default and means: no correction.

Otherwise controller speed will be adjusted as follows:

$$response_new = response_old \cdot \frac{(128 - respstable)}{1.05}$$

4.1.6 Changing Default Control Mode

Instruments are delivered with either analog or digital signal as default setpoint, depending on customer's requirement.

After every (power on) reset the instrument will return to its default control mode.

The default control mode can be changed with the following parameter:

IOStatus

Type	Access	Range	FlowDDE	FlowBus	ModBus PDU
Unsigned char	RW 	0...255	86	114/11	0xF258/62041

Bit 6 [7..0] represents the former analog jumper.

1 = default control mode is analog

0 = default control mode is digital

Procedure for changing default digital operation to default analog operation:

- Read IOStatus
- Add 64 to the read value ($OR[0x40]$)
- Write IOStatus

Procedure for changing default analog operation to default digital operation:

- Read IOStatus
- Subtract 64 from the read value ($AND[\overline{0x40}]$)

- Write IOstatus

4.1.7 Display Filter

The output signal of an EL-FLOW *Base* instrument (measured value) is filtered. The filter has dynamic behaviour: when a change in sensor signal is detected, the measured value will be less filtered than when the sensor signal is constant and stable.

There are two filter constants: Static Display Factor and Dynamic Display Factor.

These two factors can be transformed into time constants using the following formula:

$$\tau = \text{cycletime} \cdot \frac{1 - \text{factor}}{\text{factor}}$$

The measured value is filtered with a first order low pass filter with a filter time constant between these two τ values.

Dynamic Display Factor

Type	Access	Range	FlowDDE	FlowBus	ModBus PDU
Float	RW 	0 ... 1.0	56	117/1	0xF508..0xF509/62729..62730

Static Display Factor

Type	Access	Range	FlowDDE	FlowBus	ModBus PDU
Float	RW 	0 ... 1.0	57	117/2	0xF511..0xF512/62737..62738

CycleTime

Type	Access	Range	FlowDDE	FlowBus	ModBus PDU
Unsigned char	R	0...255	52	114/12	0x0E4C/3661

Note: The unit of parameter CycleTime is 10ms. Example: value 0.2 means 2ms

4.1.8 Disabling Micro Switch

It is possible to disable the Micro Switch on top of the instrument. This can prevent undesired use of this button.

Disabling the micro switch can be performed with the following parameter:

IOstatus

Type	Access	Range	FlowDDE	FlowBus	ModBus PDU
Unsigned char	RW 	0...255	86	114/11	0xF258/62041

Bit 3 [7..0] is used to disable the micro switch.

0 = micro switch disabled

1 = micro switch enabled

Procedure to enable the micro switch:

- Read IOstatus
- Add 8 to the read value
- Write IOstatus

Procedure to disable the micro switch:

- Read IOstatus
- Subtract 8 from the read value
- Write IOstatus

4.2 Using other gasses than specified

Each instrument has been calibrated and adjusted for customer process conditions. Controllers or valves may not operate correctly, if process conditions vary too much, because of the restriction of the orifice in the valve. For flowmeters performance and accuracy may be affected tremendously if physical fluid properties such as heat capacity and viscosity change due to changing process conditions. Check chapter 1.7, "Operating Principles", for detailed information about the sensor principle.

4.2.1 Software for conversion factor calculation

Bronkhorst® gathered the physical properties of over 600 fluids in a database called FLUIDAT. Application software, such as FLOW CALCULATIONS, enables the user to calculate accurate conversion factors, not only at 20°C/1 atm but at any temperature/pressure combination, both for gases and for liquids. Apply to your distributor for more details of this software.



Check FLUIDAT® on <http://www.fluidat.com>

FLUIDAT® is a collection of routines to calculate physical properties of gases and liquids. These routines are made available at the FLUIDAT® on the Net website.

4.2.2 Maximum pressure drop

For (pilot) solenoid operated control valves with small orifices the maximum allowable pressure drop for gases is according to the table.

Diameter [mm]	K _v	Normally closed Δp max. [bard]	Normally opened Δp max. [bard]
0,05	4,33 x 10 ⁻⁵	40	30
0,07	8,48 x 10 ⁻⁵	30	20
0,10	1,73 x 10 ⁻⁴	30	20
0,14	3,39 x 10 ⁻⁴	30	20
0,20	6,93 x 10 ⁻⁴	30	20
0,30	1,56 x 10 ⁻³	30	20
0,37	2,37 x 10 ⁻³	30	20
0,50	4,33 x 10 ⁻³	30	20
0,70	8,48 x 10 ⁻³	24	15
1,00	1,73 x 10 ⁻²	12	8
1,30	2,93 x 10 ⁻²	8	5
1,50	3,90 x 10 ⁻²	6	n.a.
1,70	5,00 x 10 ⁻²	5	n.a.
2,00	6,63 x 10 ⁻²	3,6	n.a.
4,50	3,50 x 10 ⁻¹	5	n.a..

For pilot operated valves the maximum pressure drop is limited to 20 bard. If the pressure drop during start-up is higher, it is preferred to install a bypass valve. During start-up this valve should be opened. Also the minimum pressure drop is limited. For exact figures consult factory or proceed according to the technical data and/or additional instructions given by the sales office or department.

5 Troubleshooting

5.1 General

For a correct analysis of the proper operation of a flow/pressure meter or controller it is recommended to remove the unit from the process line and check it without applying fluid supply pressure. In case the unit is dirty, this can be ascertained immediately by loosening the compression type couplings and, if applicable the flange on the inlet side.

Energizing or de-energizing of the instrument of the instrument indicates whether there is an electronic failure.

After that, fluid pressure is to be applied in order to check behaviour.

If there should be suspicion of leakage in case of a gas unit, do not check for bubbles with a leak detection liquid under the cover as this may lead to a short-circuit in the sensor or p.c.board.

5.2 LED indications

The two LEDs on the instrument give information about the status of the instrument. Check chapter 3.88, "LED indications" for detailed info.

5.3 Troubleshooting summary general

Symptom	Possible cause	Action
No output signal	No power supply	1a) check power supply
		1b) check cable connection
	Output stage blown-up due to long lasting shortage and/or high-voltage peaks	1c) return to factory
	Supply pressure too high, or differential pressure across meter too high	1d) lower supply pressure
	Valve blocked/contaminated	1e) connect 0 .. 15 Vdc to valve and slowly increase voltage while supply pressure is 'on'. The valve should open at $7V \pm 3V$; if not open, then cleaning parts and adjust valve (qualified personnel only)
	Screen in inlet fitting blocked	1f) clean screen
	Sensor/capillary failure	1g) return to factory
Maximum output signal	Output stage blown-up	2a) return to factory
	Sensor/capillary failure	2b) return to factory
Output signal much lower than setpoint signal or desired flow	Screen blocked/contaminated	3a) clean screen
	LFD blocked/contaminated and/or liquid in meter	3b) remove LFD and clean; dry meter with air or N_2
	Valve blocked/contaminated	3c) clean valve
	Valve internal damage (swollen seat in plunger)	3d) replace plunger assembly and adjust valve or return
	Incorrect type of gas is used and/or pressure/diff. pressure	3e) try instrument on conditions for which it was designed
Flow is gradually decreasing	Condensation, occurs with NH_3 , hydrocarbons such as C_3H_8 , C_4H_{10} etc.	4a) decrease supply pressure and/or heat gas to be measured
	Valve adjustment has changed	4b) see '1e'
Oscillation	Supply pressure/diff. pressure too high	5a) lower pressure
	Pipeline too short between pressure regulator and MFC	5b) increase length or diameter of piping upstream
	Pressure regulator is oscillating	5c) replace pressure regulator or try '5b'
	Valve sleeve or internals damaged	5d) replace damaged parts and adjust valve, see '1e' or return to factory
	Controller adjustment wrong	5e) adjust controller

Symptom	Possible cause	Action
Small flow at zero setpoint	Valve leaks due to damaged plunger or dirt in orifice	6a) clean orifice and/or, when replacing plunger assembly, see '1e'
	Pressure too high or much too low	6b) apply correct pressure
High flow at zero setpoint	Damaged diaphragm (only applicable to valves with membrane)	7a) replace membrane seal

6 Removal and Return Instructions

Instrument handlings:

- Purge gas lines
- Remove instrument from line
- Insert the instrument into a plastic bag and seal the bag
- Place the bag in a appropriate shipping container

Add documentation:

- Reason of return
- Failure symptoms
- Contaminated condition
- Declaration on Contamination form: 9.17.032

When returning material, always describe the problem and if possible the work to be done, in a covering letter.

It is absolutely required to notify the factory if toxic or dangerous fluids have been metered with the instrument!

This to enable the factory to take sufficient precautionary measures to safeguard the staff in their repair department. Take proper care of packing, if possible use the original packing box; seal instrument in plastic etc.

All instruments must be dispatched with a completely filled in 'declaration on contamination form'. Instruments without this declaration will not be accepted.

Note:

If the instruments have been used with toxic or dangerous fluids the customer should pre-clean the instrument.

Important:

Clearly note, on top of the package, the customer clearance number of Bronkhorst High-Tech B.V., namely:

NL801989978B01

If applicable, otherwise contact your distributor for local arrangements.



*The declaration on contamination form is available at the Bronkhorst download site:
<http://www.bronkhorst.com/en/downloads/>*

7 Service

For current information on Bronkhorst® and service addresses please visit our website:

 <http://www.bronkhorst.com>

Do you have any questions about our products? Our Sales Department will gladly assist you selecting the right product for your application. Contact sales by e-mail:

 sales@bronkhorst.com

For after-sales questions, our Customer Service Department is available with help and guidance. To contact CSD by e-mail:

 support@bronkhorst.com

No matter the time zone, our experts within the Support Group are available to answer your request immediately or ensure appropriate further action. Our experts can be reached at:

 **+31 859 02 18 66**